

# 电源输入

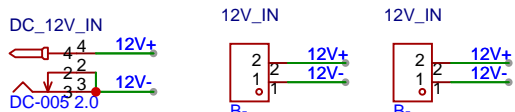

# ESP32

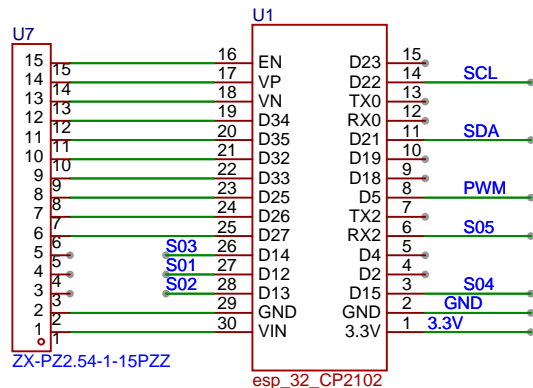

# PWM电机调速模块

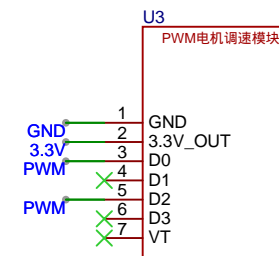

# 风扇输出

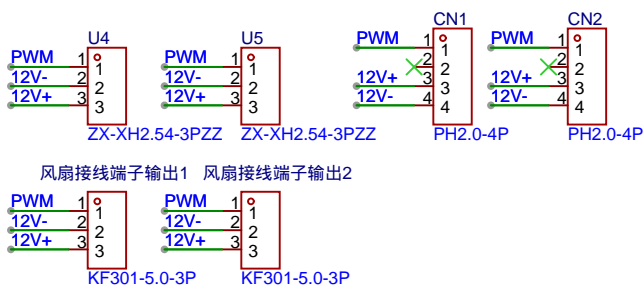

# 调节按钮排线

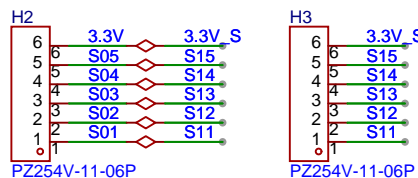

# 12V-3.3V

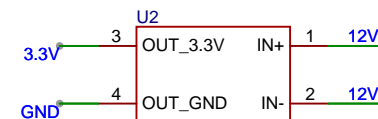

# 调节按钮

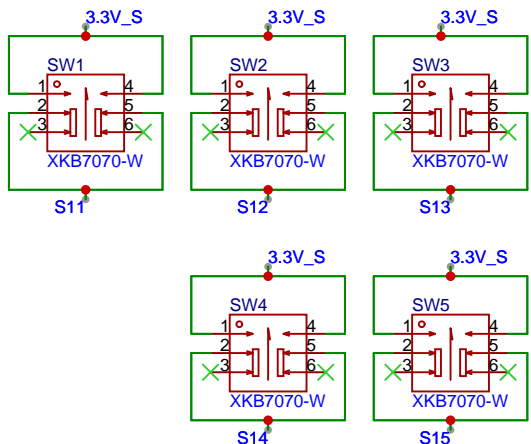

# OLED显示器

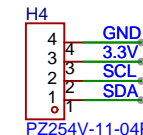

原理图	Schematic1		更新日期	2024-07-26
图页	P1		创建日期	2024-07-01
绘制			物料编码	
审阅			风压式电脑散热器_2024-07-01_22-35-42	
		版本	尺寸	页 1 共 1
嘉立创EDA		V1.0	A4	嘉立创EDA